



---

# NORDIC ELITE SERIES CUBE ICE MAKER

## CNM 300 lb THROUGH 1400 lb CUBERS

### OWNER'S MANUAL



**Release Date: April 19, 2018**

**Publication Number: 548000033**

**Revision Date: December 18, 2018**

**Revision: B**

Visit the Cornelius web site at <http://ice.cornelius.com> for all your Literature needs.

---

## Notice

The products, technical information, and instructions contained in this manual are subject to change without notice. These instructions are not intended to cover all details or variations of the equipment, nor to provide for every possible contingency in the installation, operation or maintenance of this equipment. This manual assumes that the person(s) working on the equipment have been trained and are skilled in working with electrical, plumbing, pneumatic, and mechanical equipment. It is assumed that appropriate safety precautions are taken and that all local safety and construction requirements are being met, in addition to the information contained in this manual.

This Product is warranted only as provided in Cornelius' Commercial Warranty applicable to this Product and is subject to all of the restrictions and limitations contained in the Commercial Warranty.

Cornelius will not be responsible for any repair, replacement or other service required by or loss or damage resulting from any of the following occurrences, including but not limited to, (1) other than normal and proper use and normal service conditions with respect to the Product, (2) improper voltage, (3) inadequate wiring, (4) abuse, (5) accident, (6) alteration, (7) misuse, (8) neglect, (9) unauthorized repair or the failure to utilize suitably qualified and trained persons to perform service and/or repair of the Product, (10) improper cleaning, (11) failure to follow installation, operating, cleaning or maintenance instructions, (12) use of "non-authorized" parts (i.e., parts that are not 100% compatible with the Product) which use voids the entire warranty, (13) Product parts in contact with water or the product dispensed which are adversely impacted by changes in liquid scale or chemical composition.

## Correct Disposal of this Product



**RECYCLE**

This marking indicates that this product should not be disposed with other household wastes throughout the EU. To prevent possible harm to the environment or human health from uncontrolled waste disposal, recycle it responsibly to promote the sustainable reuse of material resources. To return your used device, please use the return and collection systems or contact the retailer where the product was purchased. They can take this product for environmental safe recycling.

## Trademarks and Copyrights

This document contains proprietary information and it may not be reproduced in any way without permission from Cornelius. This document contains the original instructions for the unit described.

CORNELIUS INC  
101 Regency Drive  
Glendale Heights, IL  
Tel: + 1 800-238-3600

Printed in U.S.

## Contact Information

To inquire about current revisions of any documentation or assistance with any Cornelius product, contact:

**[www.cornelius.com](http://www.cornelius.com)**  
**800-238-3600**



# TABLE OF CONTENTS

<b>SAFETY INSTRUCTIONS</b> .....	<b>5</b>
Safety Overview .....	5
Safety Alert symbol .....	5
Types of Alerts .....	5
Safety Tips .....	5
Qualified Service Personnel .....	5
Safety Precautions .....	6
Shipping And Storage .....	6
Unit Location .....	6
Machine Usage .....	6
Freight Claims .....	7
Inspect Promptly .....	7
Visible Loss or Damage .....	7
Concealed Loss or Damage .....	7
How to use this Manual .....	7
Cornelius Warranty .....	7
<b>INSTALLATION GUIDELINES</b> .....	<b>8</b>
Ambient Operating Temperature .....	8
Incoming Water Supply .....	8
Water Filtration/Treatment .....	8
Drains .....	8
Clearance Requirements .....	9
Stacking .....	9
Dispenser Application .....	9
Electrical Specifications .....	9
Adjustments .....	9
Remote Condenser Installation .....	10
Location Limits .....	10
Calculation Formula .....	10
Remote Condenser Location .....	10
Roof Attachment .....	10
Pre-charged Line Set Routing .....	10
Equivalent Run Calculation Examples .....	12
Rise: .....	12
Drop: .....	12
Electrical and Plumbing Requirements .....	13
22" CNM SERIES Common Connections .....	13
30" CNM SERIES Common Connections .....	14



---

48" CNM SERIES Common Connections . . . . .	15
Operation of the CNM Series Cuber . . . . .	16
Freeze Cycle . . . . .	16
Harvest Cycle . . . . .	16
CNM Control Board . . . . .	16
<b>START-UP PROCEDURE . . . . .</b>	<b>17</b>
General Maintenance Procedure . . . . .	18
<b>CLEANING INSTRUCTION FOR CORNELIUS CNM SERIES ICE MACHINES . . . . .</b>	<b>19</b>
Chemicals for Descaling and Sanitizing . . . . .	21
Cleaning Stainless Steel and Aluminum . . . . .	21
Winterizing Procedures . . . . .	22
<b>CNM SERIES ICE MAKER FREQUENTLY ASKED QUESTIONS . . . . .</b>	<b>23</b>

# SAFETY INSTRUCTIONS

## SAFETY OVERVIEW



- Read and follow **ALL SAFETY INSTRUCTIONS** in this manual and any warning/caution labels on the unit (decals, labels or laminated cards).
- Read and understand ALL applicable OSHA (Occupational Safety and Health Administration) safety regulations before operating this unit.

## SAFETY ALERT SYMBOL



*This is the safety alert symbol. When you see this in the manual or on the unit, be alert to the potential of personal injury or damage to the unit.*

## Types of Alerts

 <b>DANGER</b>	Indicates an immediate hazardous situation which if not avoided <b>WILL</b> result in serious injury, death or equipment damage.
 <b>WARNING</b>	Indicates a potentially hazardous situation which, if not avoided, <b>COULD</b> result in serious injury, death, or equipment damage.
 <b>CAUTION</b>	Indicates a potentially hazardous situation which, if not avoided, <b>MAY</b> result in minor or moderate injury or equipment damage.

## SAFETY TIPS



- Carefully read and follow all safety messages in this manual and safety signs on the unit. - from Rod's doc
- Keep safety signs in good condition and replace missing or damaged items.
- Learn how to operate the unit and how to use the controls.
- **Do not** let anyone operate the unit without proper training. This appliance is **not** intended for use by very young children or infirm persons without supervision. Young children should be supervised to ensure that they do not play with the appliance.
- Keep your unit in proper working condition and do not allow unauthorized modifications to the unit.

## QUALIFIED SERVICE PERSONNEL

 <b>WARNING</b>	Only trained and certified electrical, plumbing and refrigeration technicians should service this unit. <b>All wiring and plumbing must conform to National and Local Codes. Failure to comply could result in serious injury, death or equipment damage.</b>
---	--

## SAFETY PRECAUTIONS

This unit has been specifically designed to provide protection against personal injury. To ensure continued protection observe the following:

 <b>WARNING</b>	<p>Disconnect power to the unit before servicing, following all lock out/tag out procedures established by the user. Verify all the power is off to the unit before any work is performed. Failure to disconnect the power could result in serious injury, death or equipment damage.</p>
 <b>CAUTION</b>	<p>Always be sure to keep area around the unit clean and free of clutter. Failure to keep this area clean may result in injury or equipment damage.</p>

## Shipping And Storage

 <b>CAUTION</b>	<p>Before shipping, storing, or relocating the unit, the unit must be sanitized and all sanitizing solution must be drained from the system. A freezing ambient environment will cause residual sanitizing solution or water remaining inside the unit to freeze resulting in damage to internal components.</p>
---	--

## Unit Location

 <b>CAUTION</b>	<ul style="list-style-type: none"> <li>• This unit is not designed for use in outdoor locations.</li> <li>• The appliance must be placed in a horizontal position.</li> <li>• The appliance is not suitable for installation in an area where a water jet would be used.</li> </ul>
--	---

## Machine Usage

 <b>CAUTION</b>	<ul style="list-style-type: none"> <li>• This appliance is not intended for use by persons (including children) with reduced physical, sensory or mental capabilities, or lack of experience and knowledge, unless they have been given supervision or instruction concerning use of the appliance by a person responsible for their safety.</li> <li>• Children should be supervised to ensure that they do not play with the appliance.</li> </ul>
---	--

## FREIGHT CLAIMS

### Inspect Promptly

This merchandise has been carefully inspected and packed in accordance with the carrier's packing specifications. Responsibility for safe delivery has been assumed by the carrier. If loss or damage occurs, you as the consignee must file a claim with the carrier and hold the container for carrier's inspection.

### Visible Loss or Damage

Any external evidence of loss or damage must be fully described and noted on your freight bill or express receipt and signed by the carrier's agent. The claim should be filed on a form available from the carrier.

### Concealed Loss or Damage

If loss or damage does not appear until merchandise has been unpacked, make a written request for inspection by the carrier within 5 days of the delivery date, then file a claim on a form from the carrier.

#### FILE CLAIMS WITHOUT DELAY

**DO NOT RETURN DAMAGED GOODS TO CORNELIUS.**

## How to use this Manual

Cornelius provides this manual as an aid to the service technician in installation and maintenance of the **Nordic Series** cube ice machines. Do not attempt to perform installation, start-up or maintenance unless you have read and fully understood this manual.

**NOTE: Cornelius ice-makers and dispensers are not approved for outdoor installation**

**IMPORTANT: Air and water cooled ice machines are hermetically sealed and contain fluorinated greenhouse gas R404A (GWP 3922).**

For a Service Provider,

Please contact the Cornelius Service Department at 800-238-3600 or [tech.service@cornelius.com](mailto:tech.service@cornelius.com)

Keep this manual for future reference

The CNM Series Service Parts Manuals are available separately.



#### WARNING

**Always disconnect electrical power and shut off water supply whenever maintenance or repairs are performed on the ice machine and related equipment.**



#### CAUTION

**Always wear protective eye wear whenever maintenance or repairs are performed on the ice machine and related equipment.**

## Cornelius Warranty

Every Cornelius ice maker is backed by a warranty that provides both parts and labor coverage. To view the warranty details, register products, or check your warranty status visit the "Warranty and Water Filter Registration" page on [ice.cornelius.com](http://ice.cornelius.com)

# INSTALLATION GUIDELINES

For proper operation of the ice machine, the following installation guidelines must be followed by a qualified refrigeration technician. Failure to do so may result in loss of production capacity, premature part failures, and may void all warranties.

Reference the installation parameters prior to installing the machine. Cornelius assumes no responsibility for improperly installed equipment. Excessive time required for service or time for units requiring removal for service of inaccessible equipment will be the sole responsibility of the equipment owner.

This appliance is not to be used by persons (including children) with reduced physical, sensory, or mental capabilities, or lack of experience and knowledge, unless they have been given supervision or instruction. Children shall be supervised and are not to play with the appliance.

## AMBIENT OPERATING TEMPERATURE

Minimum operating temperature: 50°F (10°C)

Maximum operating temperature: 100°F (38°C) (60 Hz.), 110°F (43°C) (50 Hz.).

**NOTE: Cornelius ice-makers and dispensers are not approved for outdoor installation**

## INCOMING WATER SUPPLY



### WARNING

**Connect to unheated potable water supply only** (see Electrical and Plumbing diagrams for line sizing).

Minimum incoming water temperature: 40°F (4.5°C)

Maximum incoming water temperature: 100°F (38°C)

Minimum incoming water pressure: 20 psi (1.4 bar, 0.138MPa)

Maximum incoming water pressure: 80 psi (5.5 bar, 0.552MPa)

**NOTE: If water pressure exceeds 80 psi (5.5 bar), a water pressure regulator must be installed.**

All water supply lines must be installed per local codes. Use 3/8 inch O.D. minimum on air cooled machines. On water cooled machines 3/8 inch O.D. minimum tubing must be run to the condenser. The water supply for the machine can "T" off from the condenser line using 3/8 inch O.D. minimum tubing. Make 2 coils of extra tubing so that the machine can be pulled away from the wall if service is needed.

**NOTE: This equipment must be installed with adequate backflow protection to comply with applicable federal state and local codes.**

## WATER FILTRATION/TREATMENT

A water filter system should be installed with the ice machine. Refer to Cornelius water filter specification sheet.

Reverse Osmosis (RO) water can be very acidic and can attack the evaporator and other metal in the ice machine. Because the RO process removes all minerals and metals from the water it can promote the faster growth of microbial mold and slime. If RO water is used, it is recommended the water pH is verified to be a neutral 7.0 to minimize the corrosive effects. Incorrect cleaners, sanitizers, and RO water that does not have a neutral pH could **void the machine's warranty**.

## DRAINS

All drain lines must be installed per local codes. Flexible tubing is not recommended. Route bin drain, purge drain and water condenser drain individually to a floor drain. The use of condensate pumps for draining water is not recommended. **Cornelius assumes no responsibility for improperly installed equipment.**



**NOTE: The purge drain fitting is plastic: DO NOT apply heat to purge drain area; DO NOT over-tighten drain connection.**

All drain lines must be installed per local codes. The purge drain should be a minimum of 3/4 inch O.D. tubing. The condenser drain on water cooled units should be 1/2 inch O.D. minimum. The drain line fittings on Cornelius bins are 3/4 FPT. The bin drain should be a minimum of 3/4 inch O.D. Cold water drains should be insulated to prevent condensation from forming.

## CLEARANCE REQUIREMENTS

Self-contained air cooled ice machines must have a minimum of 6 inches (15cm) of clearance at the rear, top, and sides for proper air circulation and adequate space for serviceability.

Self-contained air-cooled ice machines exhaust air out of the top and right side. There are two alternative air exhaust options. Option A (top exhaust bias): minimum of 6 inches (15cm) of clearance at the rear and top of the ice machine for proper function at maximum operating conditions. Option B (side exhaust bias): minimum of 6 inches (15cm) of clearance at the rear and right side of the ice machine with a minimum of 3 inches (7.5cm) of clearance at the top for proper function at maximum operating conditions.

Appropriate space should be allowed for proper serviceability of the machine. Excess time to gain access for serviceability is **not covered under warranty**.

## STACKING

Cornelius does not endorse stacking ice machines.

## DISPENSER APPLICATION

A thermostatic bin control kit should be installed if the ice machine is placed on a dispenser. A bin top may or may not be required and should be secured to the dispenser.

## ELECTRICAL SPECIFICATIONS

Refer to the serial plate at the rear of the ice machine to make sure proper voltage and circuit breaker size have been supplied. Make sure the machine is on a dedicated circuit. European installations require that the electrical supply fixed wiring must be provided with a disconnect means having a separation of at least 3mm in all poles. The ice machines are provided **without** an electrical cord set and are designed and agency approved to be permanently connected.

**NOTE: Units are not approved for GFI outlets.**



### CAUTION

Electrical connection must be made or a cord installed by a **qualified electrician** or there is danger of an electrical fire.

## ADJUSTMENTS

Level the machine within 1/8 inch in all directions. Check the water in the Water Sump for proper level.

Check the ice bridge for proper thickness. Check the Water Regulating Valve adjustment if water cooled.

Secure the machine on top of the bin or dispenser. Attach the ice machine to the bin with the mounting straps provided with the bin or dispenser. Insure that the back of the ice machine is flush with the back of the bin. Proper functioning of the Bin Door requires the door, when it is opened, to be in a stable position.

If the ice machine is too far forward on the bin, the opened door may not be stable, resulting in an unexpected closing of the bin door. If the ice machine is to be mounted on a bin or dispenser other than a Cornelius, refer to the manufacturer's instructions for machine mounting. Cornelius will not be responsible for damage or injury that results from unexpected closing of the bin door as a result of the ice machine being too far forward on the bin.

## REMOTE CONDENSER INSTALLATION

For proper operation of the ice machine, the following installation guidelines must be followed. Failure to do so may result in loss of production capacity, premature part failure, and may **void all warranties**.

**Use the following for planning the placement of the remote condenser relative to the ice machine**

### LOCATION LIMITS

Remote condenser location must not exceed **ANY** of the following:

- Maximum rise from the ice machine to the remote condenser is 35 physical feet.
- Maximum drop from the ice machine to the remote condenser is 10 physical feet.
- Physical line set maximum length is 75 ft.
- Calculated line set length maximum is 100 ft.
- Ambient operating temperatures: -20°F (-28.9°C) to 120°F (48.9°C)

### CALCULATION FORMULA

Drop = dd x 6.6 (dd = drop distance (ft.))

Rise = rd x 1.7 (rd = rise distance (ft.))

Horizontal Run = hd (hd = horizontal distance (ft.))

Calculated Line Length = Drop + Rise + Horizontal Run

**NOTE: Configurations that do NOT meet these requirements must receive written authorization from the manufacturer. This includes multi-pass or rack system remote condensers.**

**NOTE: Do NOT route a line set that rises, then falls, then rises or a line set that falls, then rises, then falls.**

### REMOTE CONDENSER LOCATION

Pre-charged line sets are available in 25, 40 or 75 foot length to connect the ice machine to the remote condenser. Select the best available location, protecting the remote condenser from extremes of dirt, dust and sun. Meet all applicable building codes. The services of a licensed electrician may be required.

### ROOF ATTACHMENT

Install and attach the remote condenser to the roof of the building using the methods and practices of construction that conform to the local building codes, including having a roofing contractor secure the remote condenser to the roof.

Have an electrician connect the remote condenser fan motor wires to the ice machine using the junction box at the back of the machine.

### PRE-CHARGED LINE SET ROUTING



#### CAUTION

**Do not connect the pre-charged tubing until all routing and forming of the tubing has been completed. See the coupling instructions for connecting information.**

Each set of pre-charged tubing refrigerant lines consists of a 3/8 diameter liquid line and 1/2 inch diameter discharge line. Both ends of each line have quick connect couplings, one end of the line set has a Schrader valve connection.

**NOTE: The openings in the building or ceiling or wall, listed in the next step, are the minimum sizes recommended for passing the refrigerant lines through.**

Have a roofing contractor cut a minimum hole for the refrigerant lines of 2.50 inch. Check local codes, a separate hole may be required for the electrical power to the condenser.



**CAUTION**  
**DO NOT KINK OR CRIMP REFRIGERANT TUBING WHEN INSTALLING IT.**

Route the refrigerant lines through the roof opening. Follow straight line routing whenever possible. Any excess tubing **MUST** remain with the building. Spiral the excess length of pre-charged tubing inside the building. Use a horizontal spiral to avoid any traps in the lines. Have the roofing contractor seal the holes in the roof per local codes.



**CAUTION**  
**The couplings on the sets of pre-charged lines are self sealing when installed properly. Carefully follow the instructions in the Remote Condenser manual.**

The following remote ice makers incorporate the Mixing Valve in the condenser. This configuration allows up to a 100 foot calculated remote line set run. Reference the diagram on the next page to calculate the maximum 100 ft. line set run. Maximum **actual line set run** is limited to 100 ft. Add 1/4 oz. of refrigerant for each actual foot from 75 to 100 ft. actual line set run.

CNM Machine Model Number	Remote Condenser Model Number
CNM0630R/0830R/1030R	RCN1061

**NOTE: \*Verify the ice machine is compatible with the remote condenser. For more information contact your distributor.**

## EQUIVALENT RUN CALCULATION EXAMPLES

Formula for maximum equivalent run:

$$(\text{RISE} \times 1.7) + (\text{DROP} \times 6.6) + \text{HORIZONTAL RUN} = \text{EQUIVALENT RUN}$$

**NOTE: NOT TO EXCEED 100 CALCULATED FEET**

### Rise:

$$(35 \text{ ft.} \times 1.7) + (40 \text{ ft.}) = 99.5 \text{ equivalent feet line run.}$$

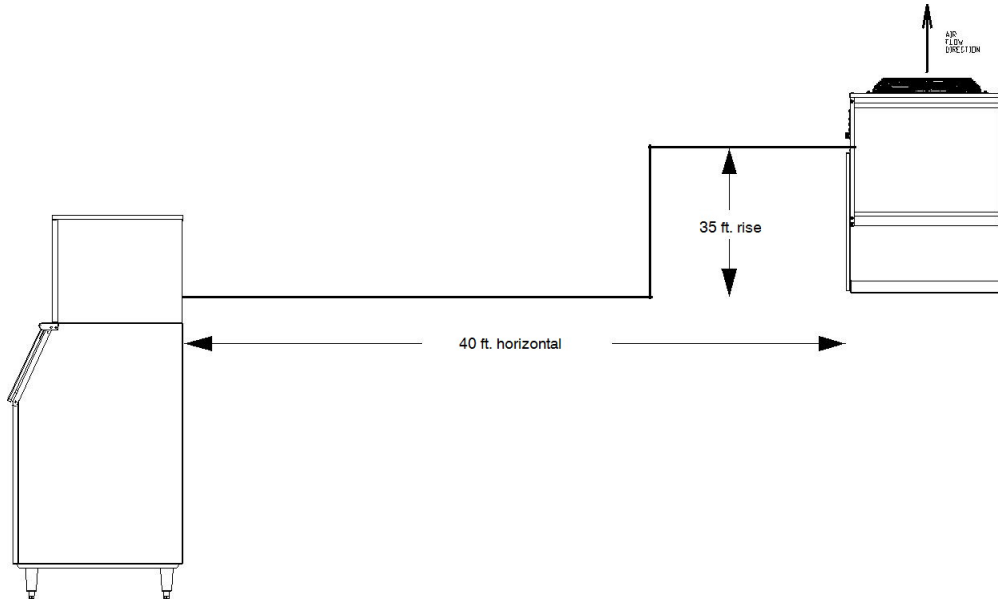

Figure 1.

### Drop:

$$(10 \text{ ft.} \times 6.6) + (34 \text{ ft.}) = 100 \text{ equivalent feet line run.}$$

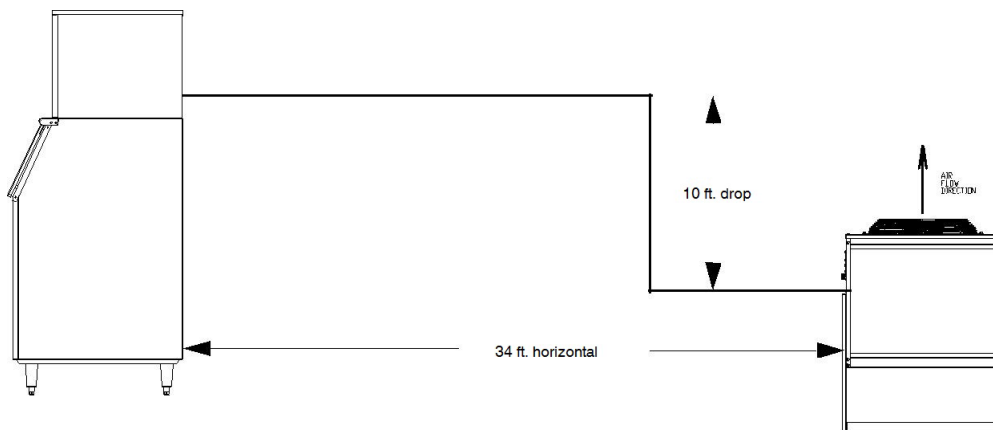

Figure 2.



## 30" CNM SERIES Common Connections

(CNM\*\*30 A\*0/5/6)

### Air Cooled

**NOTE:** Air-cooled units require 6" (152mm) for air intake and exhaust.

- A. Ice maker potable water in, 3/8" FPT.
- B. Ice maker water out, 3/4" FPT.
- C. Hole for electrical connections, 7/8".
- D. Electrical junction box, 7/8".

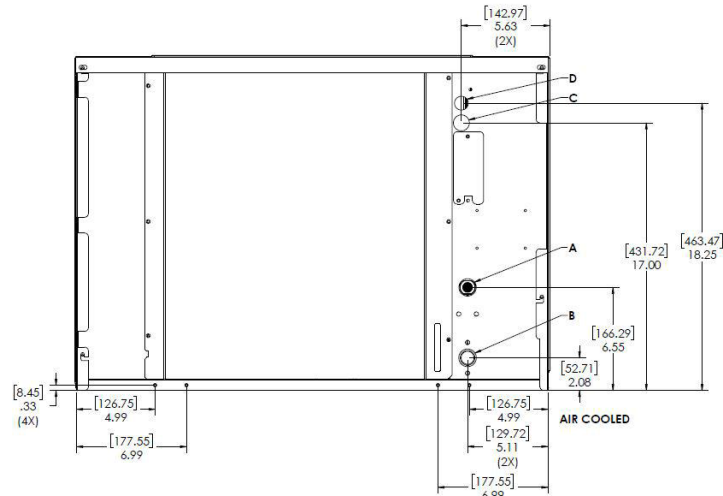

Figure 5.

CNM\*\*30 W/R\*0/5/6

### Water/Remote Cooled

- A. Ice maker potable water in, 3/8" FPT.
- B. Ice maker water out, 3/4" FPT.
- C. Hole for electrical connections, 7/8".
- D. Electrical junction box, 7/8" (remote).
- E. Condenser water in, 3/8" FPT (water only). Discharge line, 1/2" male quick connect coupling for pre-charged line set (remote only).
- F. Condenser water out, 1/2" FPT (water only).
- G. Liquid Line, 3/8" male quick connect coupling for pre-charged line set (remote only).

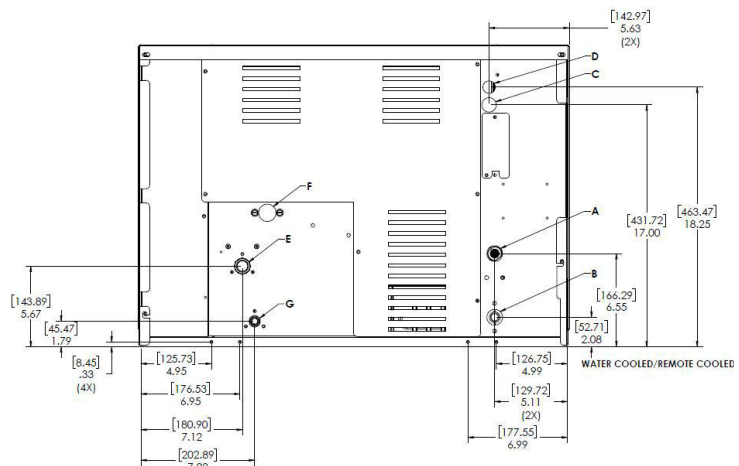

Figure 6.

## 48" CNM SERIES Common Connections

(CNM\*\*48 A\*6)

### Air Cooled

**NOTE:** Air-cooled units require 6" (152mm) for air intake and exhaust.

- A. Ice maker potable water in, 3/8" FPT.
- B. Ice maker water out, 3/4" FPT.
- C. Hole for electrical connections, 7/8".
- D. Electrical junction box, 7/8".

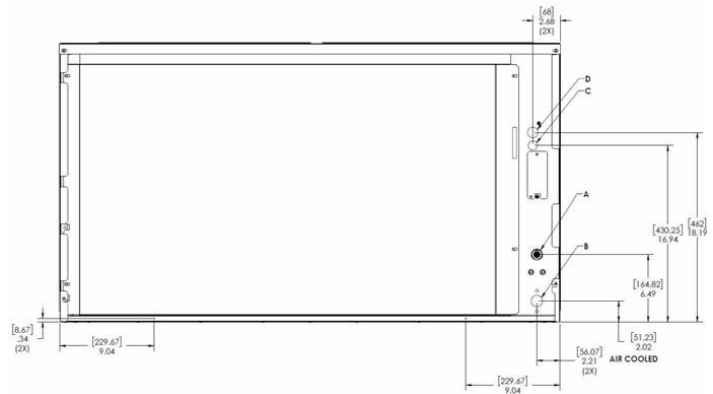

Figure 7.

CNM\*\*48 W/R\*6

### Water/Remote Cooled

- A. Ice maker potable water in, 3/8" FPT.
- B. Ice maker water out, 3/4" FPT.
- C. Hole for electrical connections, 7/8".
- D. Electrical junction box, 7/8" (remote).
- E. Condenser water in, 3/8" FPT (water only). Discharge line, 1/2" male quick connect coupling for pre-charged line set (remote only).
- F. Condenser water out, 1/2" FPT (water only).
- G. Liquid Line, 3/8" male quick connect coupling for pre-charged line set (remote only).

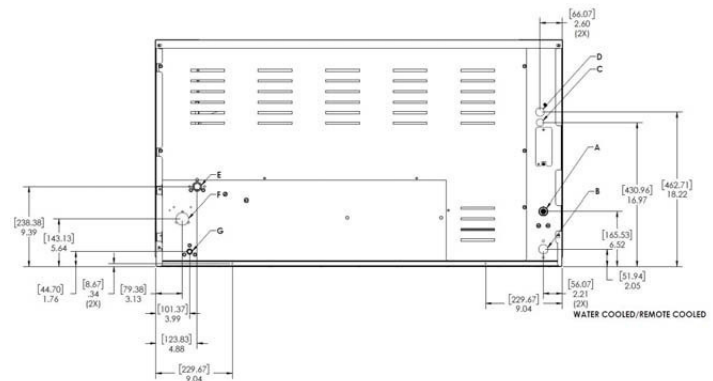

Figure 8.

# OPERATION OF THE CNM SERIES CUBER

## Freeze Cycle

A quick press and release of the ON/OFF button will start operation of the unit. The Water Inlet Valve is energized. Once the HI Water Float is in the open position the Water Inlet is de-energized. The Hot Gas Valve will open for 5 seconds. The Compressor will be energized and 5 seconds later the Hot Gas Valve will close, starting the Pre-chill of the Evaporator. The Fan Motor (if applicable) will start once the Fan Control closes. After the Pre-chill ends, the Water Pump will be energized. Water is now flowing across the Evaporator.

When the water temperature reaches a predetermined factory set point (near freezing), the unit will perform a 20 second shut down of the Water Pump to assist in Anti-Slush of the water in the Sump. At the conclusion of Anti-Slush, the unit will continue in freeze mode until the Low Water Float is satisfied (closes), indicating the formation of a full slab of Ice on the Evaporator and will start the harvest Cycle.

## Harvest Cycle

The Fan Motor shuts down as the Hot Gas Valve, Purge Valve and Water Inlet Valve are energized. The Water Inlet Valve will stay energized for additional time after the Purge Valve closes, partially filling the Water Sump.

The unit continues in this mode until the Harvest Assist Assembly helps push the ice slab from the plate and the contacts in the Curtain Switch open as the slab drops into the bin. If the Curtain Switch remains open after the factory preset time in the Harvest Cycle, the unit will shut down on a full bin. If the Curtain opens and closes with the harvest of the ice, the unit will restart the next freeze cycle.

Proper bridge thickness, when measured at the middle of the slab, on the CIM units is approximately 3/16" thick for units less than 400 lbs. and 1/8" for 400 lbs. and above.

## CNM Control Board

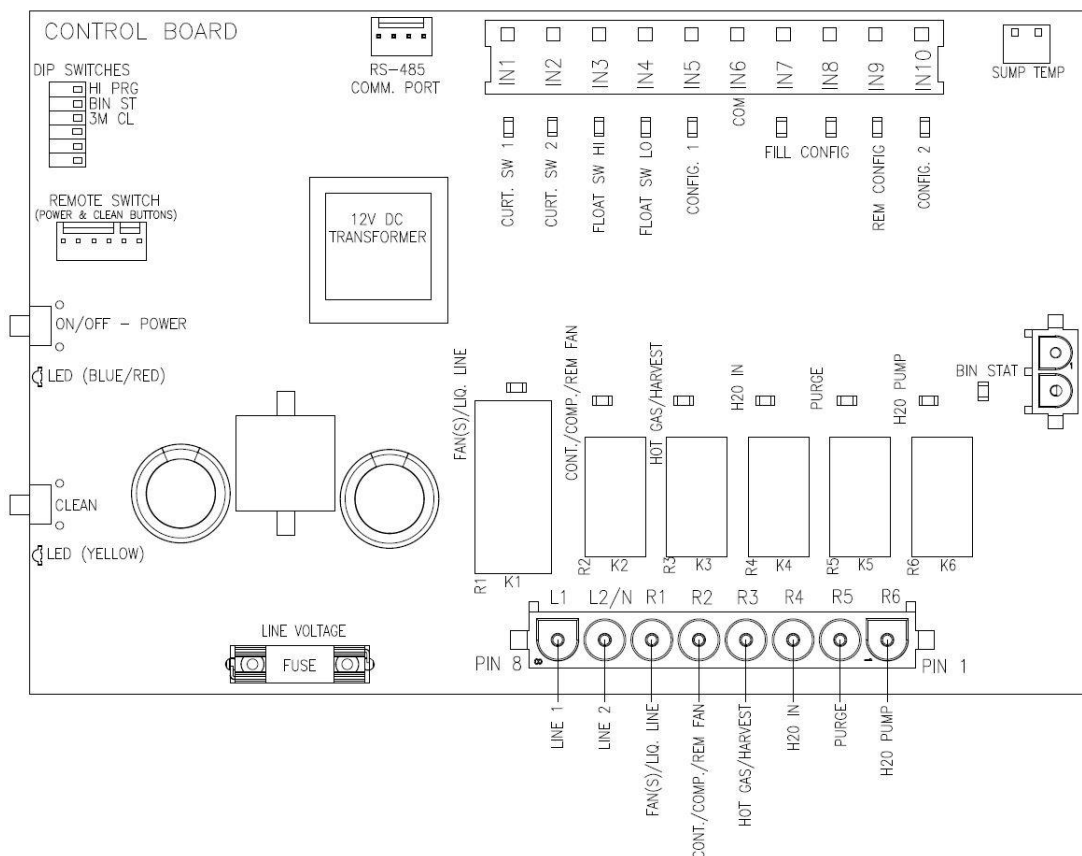

Figure 9.



# START-UP PROCEDURE

**NOTE:** Before starting the machine, make sure the machine is level within 1/8 inch in all directions, the bin or dispenser leg height can be adjusted by rotating the leg foot.

After verifying proper voltage, water supply, drains and breathable air space around the unit, press and quickly release the ON/OFF button behind the unit front panel. The indicator light will change from a solid red to solid blue in color.

Follow the sequence of operation described under "Operation of CNM Series Cuber" in this manual. Check operation of each component through the cycle as explained in this section.

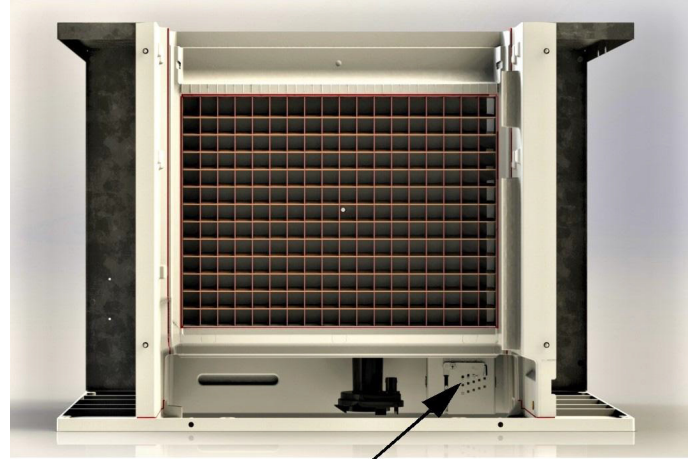

Access to Water Level Adjustment

Figure 10.

## Bridge Thickness Adjustment

Once the unit has gone through a harvest cycle, verify the bridge thickness (3/16" thick for units less than 400 lbs. and 1/8" for 400 lbs. and above) across the middle of the ice slab on the second batch produced. The ice thickness can be changed on the Float Housing by turning the adjustment clockwise to decrease the bridge thickness and counter-clockwise to increase the bridge thickness. You will hear a "click" with each adjustment. It is recommended adjustments be made one or two "clicks" at a time.

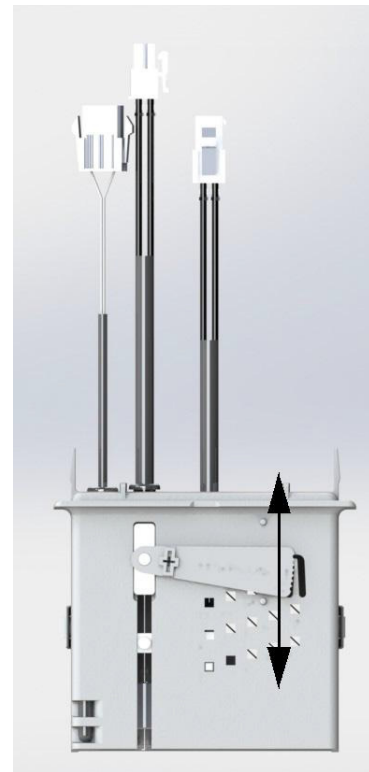

Lowers Float;  
increases bridge  
thickness.

Raises Float;  
decreases bridge  
thickness.

Figure 11.

Model	Batch Weight	
	Half Cube	Full Cube
CNM0330	2.9-3.15	3.25-3.5
CNM0530/630	4.9-5.15	5.5-5.8
CNM0830/1030	6.9-7.4	7.9-8.3
CNM1448	13.8-14.8	15.8-16.6



### WARNING

Electrical shock and/or injury from moving parts inside this machine can cause serious injury. Disconnect electrical supply to machine prior to performing any adjustments or repairs.

Failure to perform the required maintenance at the frequency specified will void warranty coverage in the event of a related failure.

## GENERAL MAINTENANCE PROCEDURE

To insure economical, trouble free operation of your machine; it is recommended that the following maintenance be performed every 6 months.

1. Clean the ice-making section per the instructions below. Cleaning should be performed a minimum of every 6 months. Local water conditions may require that cleaning be performed more often.
2. Check ice bridge thickness. See Figure 11. for proper thickness and adjustment procedure.
3. Check water level in Sump. See Figure 11. for proper water level and adjustment procedure.
4. Clean the condenser (air-cooled machines) to ensure unobstructed air flow.
5. Check for leaks of any kind: water, refrigerant, oil, etc.
6. Check the bin control switch (if applicable) for proper adjustment.
7. Check the Water Regulating Valve (water cooled machine) for proper adjustment by measuring the discharge pressure which should be adjusted to maintain 250 psi (17.01 bar/ 1.723 MPa). Adjust the water regulating valve as required. Water exiting the condenser should be between 100°F (38°C) and 110°F (43°C).
8. Check all electrical connections.
9. Oil the fan motor if the motor has an oil fitting. (Self contained air-cooled models only)
10. Check the water filter (if applicable) and replace if dirty or restricted.
11. Inspect the evaporator water distribution tube to insure even distribution of water across the face of the evaporator.
12. Clean Remote Condenser if applicable.

# CLEANING INSTRUCTION FOR CORNELIUS CNM SERIES ICE MACHINES

**NOTE:** Proper cleaning of an ice machine requires two parts: descaling and sanitizing.

**Descaling** should be scheduled at a minimum of twice per year but no more than once per month.

Descaling dissolves the mineral deposits on the evaporator and other surfaces. It removes scale, calcium, lime scale and other mineral buildup. The manufacturer requires a “nickel-safe” cleaner such as Nu-Calgon Nickel-Safe Ice Machine Cleaner or equivalent diluted per manufacturer’s instructions.

**Sanitizing** should be performed after each descaling but no more than once per month.

Sanitizing disinfects the machine and removes microbial growth including mold and slime. The manufacturer requires a “nickel-safe” sanitizer such as Nu-Calgon IMS-III or equivalent diluted per manufacturer’s instructions.



## CAUTION

**Do not mix cleaner (descaler) and sanitizer together.**

**NOTE:** Electrical power will be ON when performing the following cleaning instructions.

1. Remove all ice from storage means to prevent any contamination of ice in storage.
2. Remove the front panel of the ice machine by loosening the two front panel screws with a Phillips head screwdriver. Lift panel to remove.
3. Press and hold the POWER button for 3 seconds to initiate a harvest cycle (blue light will begin to flash for Manual Harvest mode). This ensures there is no ice on the plate and the water is emptied from the sump.

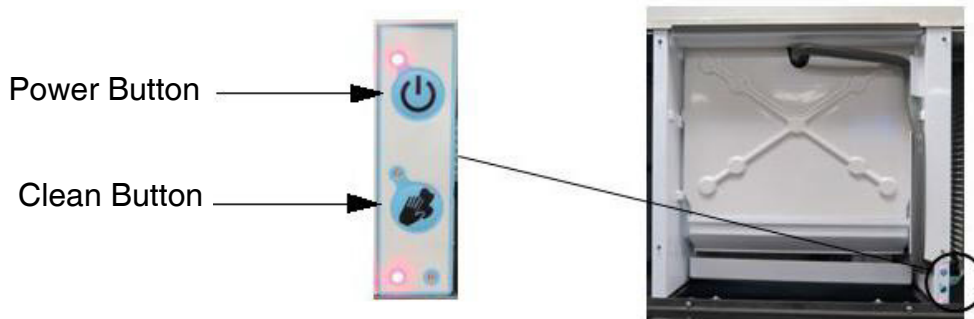

Figure 12.

4. Once the ice machine has completed its harvest cycle, the POWER light will go to solid red (OFF mode).
5. Remove the upper evaporator cover and leave the lower curtain.

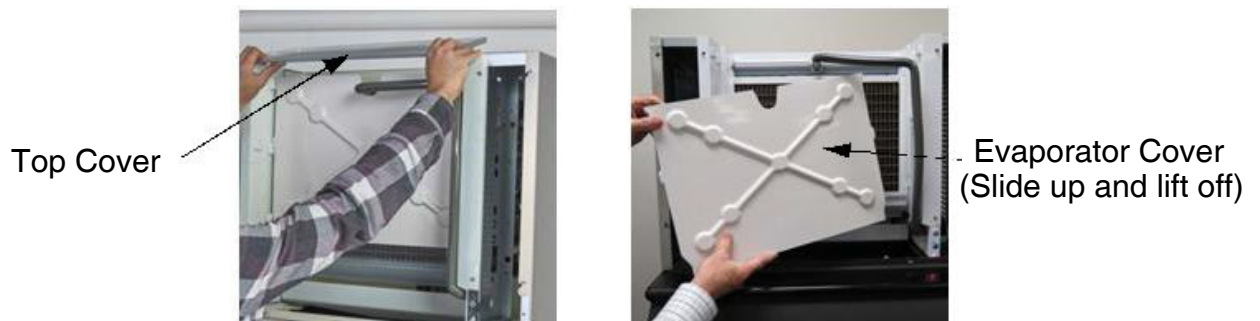

Figure 13.

6. Quick press the CLEAN button to start the process. Ice machine will show a solid red and flashing yellow light during the cleaning cycle.
7. The machine will first verify that the sump is empty with the pump ON and the purge valve energized.
8. When the sump is mostly empty, the machine will begin to fill the sump (about 30 seconds to a minute).
9. The pump turns ON when the water fill reaches the proper fill level. Measure the appropriate amount of descaler according to the machine size and sump volume from [chart below](#). Carefully pour the descaler into the sump using the lower curtain to prevent splash. Replace upper evaporator cover

Model (Approx. Machine Capacity)	Sump Size (volume) Gallons (in liters)	Example: Nu-Calgon Nickel-Safe Ice Machine Cleaner Descaler Concentration Ratio 5 fl.oz. per 1 gal. of water (39 mL per 1 Liter of water)	Example Nu-Calgon IMS-III Sanitizer Concentration Ratio 1.6 fl. oz. per 1 gal. of water (12.5 mL per 1 Liter of water)
CNM0330	.9 (3.4)	Add 4.5 fl. oz. (133 mL)	Add 1.5 fl. oz. (44mL)
CNM0530/630	1.2 (4.5)	Add 6 fl. oz. (177 mL)	Add 2 fl. oz. (59 mL)
CNM0830/1030	1.1 (4.2)	Add 5.5 fl. oz. (164 mL)	Add 1.8 fl. oz. (53 mL)
CNM1448	1.8 (6.8)	Add 9.0 fl. oz. (265 mL)	Add 2.9 fl. oz. (85 mL)

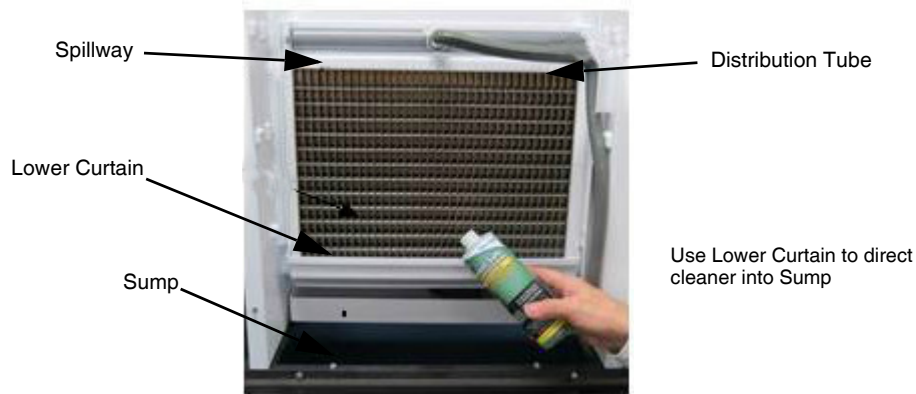

Figure 14.

10. The machine will remain in the WASH cycle for 15 minutes.
11. After WASH time, the machine will PURGE and re-fill with the water pump ON.
12. The machine will RINSE (less than one minute) then repeat PURGE/FILL/RINSE multiple times.
13. The machine will end the cleaning cycle with a mostly empty sump and a solid red and yellow light.
14. Quick press the CLEAN button to return to OFF mode.
15. Remove the upper evaporator cover and lower evaporator curtain. Using a solution with the proper concentration of cleaner (descaler or sanitizer), wipe down with a clean soft cloth the evaporator, water spillway, water distributor, upper evaporator cover, lower evaporator curtain and all splash surfaces. Verify that all residue and residual minerals have been removed.
16. If a full clean of water components is required, this can be done by referring to the service manual for water system component breakdown. This is recommended to be done by a qualified service agent.
17. Re-assemble all ice machine water system components in reverse order.
18. Sanitizing the ice machine is recommended after descaling. Repeat the process with sanitizer at correct ratio.
19. It is recommended to clean (descale and sanitize) the storage means after cleaning the ice machine.
20. Quick press the POWER button to return the ice machine to the ice making cycle.
21. Replace the front panel and tighten the two panel screws with a Phillips screwdriver.

## CHEMICALS FOR DESCALING AND SANITIZING

It is important to use solutions that do not harm the ice machine. Never use cleaning or sanitizing solutions that contain Nitric Acid, Sulfuric Acid, Hydrochloric Acid, Carbolic Acid, Acetic Acid, diluted Acetic Acid or non-food-grade vinegar (concentration of acetic acid greater than 6% and does not contain enzymes created in processing) or any chlorine-based solution such as bleach, chlorine dioxide or any type of salts such as potassium chloride (potassium salts) or sodium chloride. Check the label or the manufacturer's Material Safety Data Sheet (MSDS) to be sure. These chemicals can attack the surface of the evaporator as well as other metal components causing corrosion and flaking.

## CLEANING STAINLESS STEEL AND ALUMINUM

Commercial grades of stainless steel and aluminum are susceptible to rusting or corrosion if not properly maintained. It is important that you properly care for the stainless steel and aluminum surfaces of your ice machine and bin to avoid the possibility of rust or corrosion.

Use the following recommended guidelines for keeping your machine looking like new:

1. **Clean the stainless steel and aluminum thoroughly once a week.** Clean frequently to avoid build-up of hard, stubborn stains. Hard water stains left to sit can weaken the metals corrosion resistance and lead to rust or corrosion. Use a nonabrasive cloth or sponge, working with, not across, the grain.
2. **Do not use abrasive tools to clean the metal surface.** Do not use steel wool, abrasive sponge pads, wire brushes or scrapers to clean the metal.
3. **Do not use cleaners that use chlorine or chlorides.** Do not use chlorine bleach products to clean the metal surfaces. Chlorides break down the metals protective layer.
4. **Rinse with clean water.** If chlorinated cleansers are used, you must thoroughly rinse the surface with clean water and wipe dry immediately.
5. **Use the right cleaning agent.** The table below lists the recommended cleaning agents for common metal cleaning problems.

Cleaning Activity	Cleaning Agent	Method of Application
Routine Cleaning	Mild dish soap, ammonia, glass cleaner, or mild detergent with water. Household kitchen cleaning chemicals approved for metal surfaces.	Apply with clean cloth or sponge. Rinse with clean water and wipe dry.
Removing grease or fatty acids	Oven cleaners	Apply generously; allow to stand for 15-20 minutes. Rinse with clean water. Repeat as required.
Removing hard water spots and scale	Vinegar	Swab or wipe with clean cloth. Rinse with water and wipe dry.

## WINTERIZING PROCEDURES

**IMPORTANT:** Whenever the ice machine is taken out of operation during the winter months, the procedure below must be performed. Failure to do so may cause serious damage and will void all warranties.

1. Turn off water to machine.
2. Make sure all ice is off of the evaporator(s). If ice is being made, initiate harvest by pressing the Power Button for approximately 3 seconds. The unit will shut off automatically following the harvest.
3. Disconnect the tubing between the water pump discharge and water distribution tube and drain any water.
4. On water cooled machines, hold the water regulating valve open by prying upward on the water valve spring with a screwdriver while using compressed air to blow all the water out of the condenser.

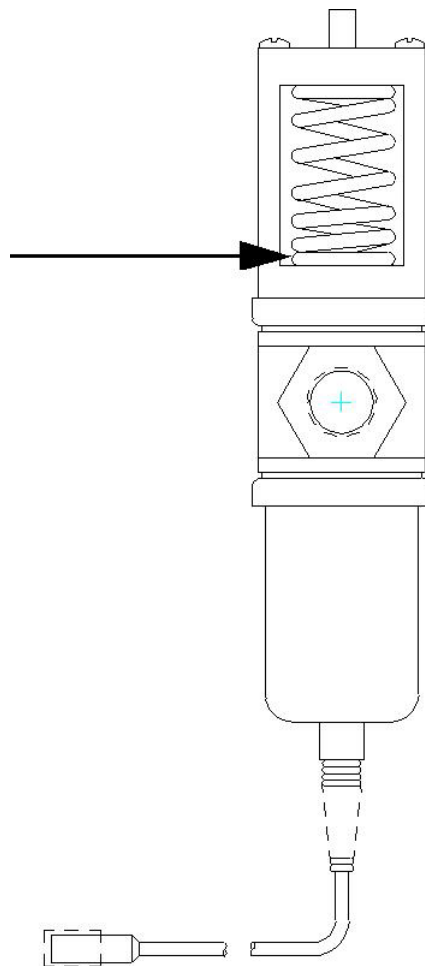

Figure 15.

5. Remove all of the ice in the storage bin and discard,

# CNM SERIES ICE MAKER FREQUENTLY ASKED QUESTIONS

## 1. What is the factory float setting on a replacement float assembly?

Replacement float housings come with the high float set in the #1 position. The high float needs to be inserted, per the provided instruction, into the correct float setting of the machine receiving the replacement float assembly.

## 2. What is the factory high float setting on a new machine?

The CNM series float settings by nominal capacity are listed below

<u>Nominal Capacity</u>	<u>Half</u>	<u>Full</u>	<u>Grande</u>
300lbs	#2	#3	-
400 through 600lbs	#8	#9	-
800 through 1100lbs	#3	#4	#5
1400lbs	#4	#5	-

## 3. How do I adjust the ice bridge thickness?

The CNM series' bridge thickness may be adjusted by moving both a high and a low float.

- The low float is used for fine bridge thickness adjustment via an adjustment arm. Turning this arm counter-clockwise lowers the float and increases bridge thickness. Rotating the arm clockwise raises the low float, decreasing bridge thickness.
- A greater change to the bridge thickness than the low float adjustment can provide is possible by moving high float up or down one position. Moving the high float up increases bridge thickness, while moving this float down, decreases the bridge thickness.

## 4. Why is my new machine occasionally producing extra thick batches of ice?

When occasional thick batches of ice occur, the bridge thickness may be set too low. When a batch of ice does not have a thick enough bridge, it can split and only have half a batch fall into the ice bin. The curtain is opened and closed by this half batch, causing the machine to go back into freeze mode. The remaining ice from the previous cycle is added to the new batch of ice being formed, causing it to be especially thick.

## 5. Why causes the machine to produce cloudy/hazy ice?

Cloudy ice is the result of impurities getting trapped as the ice forms. These impurities include dissolved mineral, chemicals, and air. These are a few items to consider if your machine is producing cloudy ice:

- Verify the purge valve is operating correctly, and that the drain line inside the machine is not kinked or blocked in any way.
- Use a vented drain line from the machine to the floor drain.
- Change the machine to use the "High Purge" setting in areas with water that has an elevated concentration of dissolved minerals.
- Avoid using water that has had phosphate added or is from a water softener.

## 6. What do I do if I can't get the curtain to stay on the machine?

For curtain issues, please contact Cornelius. CNM machines built before January of 2018 are eligible for an enhanced curtain design that ensures it will stay in place under all operating conditions. Machines built after 2017 have a newer evaporator assembly design that improves the ice maker's curtain retention, and is incompatible with the enhanced curtain.

## 7. The lights on my machine are blinking, what does it mean?

The CNM series of ice makers utilizes 3 LED's to provide information on the status of the machine at a glance. More information is available on the inside of the left panel of the machine, but a basic description is as follows:

- **Solid or Blinking Blue:** A blue light indicates the machine is operating normally. It could be making ice, waiting for the ice bin to empty, or, in the case of a blinking blue light, performing a regular extended harvest.
- **Solid Red:** The machine is off.
- **Blinking Red:** If the machine is blinking red slowly (once a second) a non-critical error has occurred. The machine will still make ice, but at a reduced level of functionality. A fast red blink (twice a second) indicates a critical issue has arisen and needs to be diagnosed before the machine will continue making ice.
- **Blinking Yellow:** The yellow/amber LED begins to blink when it has been 6 months (3 months if the 3 month setting has been enabled on the control board) since the last clean cycle was run. This clean LED will be reset once a full clean cycle has been completed.





**Cornelius Inc.**  
**[www.cornelius.com](http://www.cornelius.com)**